

GEIS

UCB

Modular DIN-rail devices

GEIS Electrical Protection

Safer Smarter Greener



About GEIS

GEIS was established in 2019 following the spin-off of several businesses and assets that ABB had acquired from GE on July 1, 2018, including 3 manufacturing centers, Warehousing & Trading business at FTZ, China Technology Center.

- Components: Full range of circuit breakers up to 40.5kV: Medium voltage vacuum circuit breakers, LV circuit breakers: ACB, MCCB, MCB, RCD, RCBO: Control components.
- Equipment: MV switchgear (Air insulation and Gas Insulation Technology), LV switchgear, switchboard.
- Medium voltage distribution transformer.
- Medium voltage ATS system (Paralleling Switchgear).

After the separation, all the above product lines were rebranded as AEG for selected markets and GEIS for global markets. Moreover, GEIS has expanded its technological portfolio to include medium-voltage controls such as VFDs and soft starters, as well as ATS systems and EV chargers.



Quality is Built-in

Where Technology Meets Manufacturing Excellence for Customers

- Since 2000, we have been specializing in localizing world-class products and manufacturing technologies, developing strong expertise and a highly capable team.
- Vertical integrated Shanghai Manufacturing Center brought key manufacturing processes into a 75,000 m² facility, enabling high-quality, high-efficiency production and fostering innovation. A dedicated R&D team committed to developing products that meet global standards and serve diverse applications.
- Global expansion: GEIS's first Thailand facility makes it easier to serve customers worldwide.



GEIS deliver complete range of products for the evolving electrification needs:



SecoVac VCB



M-PACT Plus ACB



Elfa Series MCB/RCBO



SolidDrive MV VFD



SecoGear MV Switchgear



RMU Gas Insulated Switchgear



WaveCast Transformer



MLS LV Switchgear

Miniature Circuit Breakers



Applications



Certified



UCB Miniature Circuit Breakers

UCB miniature circuit breaker, rated voltage AC120/240 V, rated current 10A to 60A, short circuit breaking current 10kA, providing 1P/2P/3P circuit breakers suitable for 50/60Hz. UCB miniature circuit breakers can be used for surface, flush or DIN-rail mounted.

According to the usage preferences of the UL market, UCB miniature circuit breakers have been designed with two connection types: standard junction box method and quick plug-in terminal. The circuit breakers and terminals comply with UL 489 certification requirements and have obtained UL and CSA certificates. The product is suitable for normal connection and disconnection in situations such as terminal power distribution and industrial control, as well as providing protection under abnormal conditions such as short circuits and overloads.

Technical Data

Rated current I_n	A	10-60
Poles		1P, 2P, 3P
Rated voltage AC	V	1P: 120/240 2P: 120/240 3P: 240
Rated insulation voltage U_i	V	690
Rated impulse withstand voltage		
U_{imp}	kV	4
Interrupting Rating		
- 1P/2P, 120/240V AC	kA	10
- 3P, 240V AC	kA	10
Switching Operations		
- Full Load Operations		10,000
- No Load Operations		20,000
Reference ambient temperature	F / °C	104/40
protective class		IP20

Miniature Circuit Breakers

■ Selection Guide

UCB
Series
UCB series Circuit breaker

2	
Poles	
1	1P
2	2P
3	3P

S	
Terminal type	
S	Standard connection box type
Q	Quick plug type

60	
Rated current	
10	10A
15	15A
20	20A
25	25A
30	30A
35	35A
40	40A
45	45A
50	50A
60	60A

Remarks: S-Std. Lugs on all terminals

Q- Lugs on One Side / QC terminals on Opposite Side

■ Features

- Automatically open a circuit under overload or short circuit conditions.
- Can be surface, flush or DIN-rail mounted.
- Are fully tested, UL Listed, and CSA certified for reverse connection without restrictive line/load markings.
- QC terminal design to provide reliable wire connections.
- When the UCB miniature circuit breaker is tripped, the handle assumes a position between ON (I) and OFF (O) and the red Visi-Trip indicator appears in a window in the circuit breaker case. Reset the circuit breaker and Visi-Trip indicator by pushing the handle to OFF and then to ON.

■ Tripping Mechanisms

A tripping mechanism is an assembly within the circuit breaker molded case that causes the circuit breaker to open automatically under sustained overload or short circuit conditions. The tripping mechanisms in multipole circuit breakers operate such that an overcurrent on any pole of the circuit breaker will cause all poles of the circuit breaker to open simultaneously. Thermal and magnetic factory calibration (with current) is performed on each pole of every UCB circuit breaker.

■ Interrupting Rating

The interrupting rating of a circuit breaker is the highest current at rated voltage that the circuit breaker is intended to interrupt under standard test conditions. Circuit breakers must be chosen with interrupting ratings equal to or greater than the maximum available short-circuit current at the point where the circuit breaker is applied in the system.

UL Listed Interrupting Rating—RMS Sym. Amperes:

- 10kA, at AC Volts: 120/240V AC. (1P&2P Breaker)
- 10kA, at AC Volts: 240V AC. (3P Breaker)

Miniature Circuit Breakers

■ Ambient Temperature Rating

- Operation temperature: $-10^{\circ}\text{C} \sim +60^{\circ}\text{C}$ ($14^{\circ}\text{F} \sim 140^{\circ}\text{F}$)
- Storage temperature: $-40^{\circ}\text{C} \sim +70^{\circ}\text{C}$ ($-40^{\circ}\text{F} \sim 158^{\circ}\text{F}$)
- Relative Humidity: 90-95%RH (Below $40^{\circ}\text{C}/104^{\circ}\text{F}$)
- Altitude: $\leq 2000\text{m}$ (6562 feet)

■ Derating of Thermal-magnetic Circuit Breakers for Ambient Conditions

UCB thermal-magnetic circuit breakers are to be applied in ambient temperatures within the range of 14°F to 140°F (-10°C to 60°C). Use the following derating guidelines:

- Ambient Temperatures between 77°F and 104°F (25°C and 40°C):
 - No derating is necessary.
- Ambient Temperatures Between 14°F and 75°F (-10°C and 24°C):
 - Thermal-magnetic circuit breakers operating within this ambient temperature range will carry more than their continuous current rating without tripping. Conductor and equipment damage can result if they are not in the same low ambient environment as the circuit breaker.
 - Nuisance tripping will not be a problem. However, if closer protection of the equipment and conductor is required, the increased current carrying capacity of the circuit breaker at the lower ambient temperature should be taken into consideration.
- Ambient Temperatures Between 106°F and 140°F (41°C and 60°C):
 - Thermal-magnetic circuit breakers operating within this ambient temperature range will carry less than their continuous current rating and must be carefully selected to prevent nuisance tripping.
- To determine the continuous current carrying capacity of a thermal-magnetic circuit breaker at an ambient temperature other than 104°F (40°C), perform the following steps:

1. Choose the ambient derating curve for the specific amperage rating of the circuit breaker you wish to apply. Note that the curve crosses the 104°F (40°C) ambient temperature line at the circuit breaker's rated continuous current carrying capacity (Circuit Breaker Handle Rating on the curve).
2. Follow this curve to the appropriate ambient temperature.
3. Read the adjusted continuous current carrying capacity at this point (on the left axis).
4. Add in any other applicable factors, such as continuous loading, per the NEC requirement.

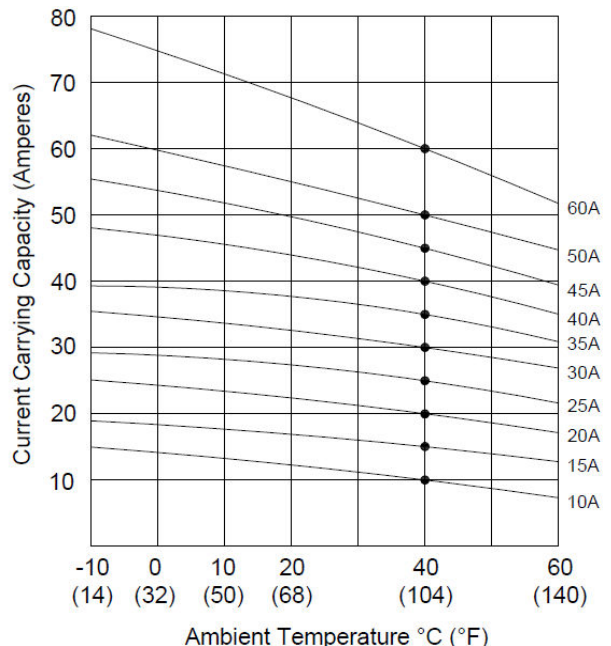

Miniature Circuit Breakers

■ Wire Gauge, Std. Lugs

Type	Ampere	No. of pole	Cu wire		Al wire	
			No. of wire	Size AWG	No. of wire	Size AWG
Lugs	10	1/2	1	14	1	12
	15	1/2/3	1	14	1	12
	20	1/2/3	1	12	1	10
	25	1/2/3	1	10	1	10
	30	1/2/3	1	10	1	8
	35	1/2/3	1	10	1	8
	40	1/2/3	1	8	1	8
	45	1/2/3	1	8	1	8
	50	1/2/3	1	8	1	6
	60	1/2/3	1	6	1	4

■ Wire Gauge, QC terminals

Type	Ampere	No. of pole	Cu wire	
			No. of wire	Size AWG
QC	10	1/2	1	14
	15	1/2/3	1	14
	20	1/2/3	1	12
	25	1/2/3	1	10
	30	1/2/3	1	10
	35	1/2/3	2	12
	40	1/2/3	2	12
	45	1/2/3	2	10
	50	1/2/3	2	10
	60	1/2/3	2	10

Miniature Circuit Breakers

■ Mounting

UCB circuit breakers offer three different installation methods, each of which fully considers the convenience of on-site use. The standard installation bracket can quickly support Flush Mounting and Surface Mounting methods, while the plastic structure located at the bottom of the circuit breaker can be easily and reliably fixed to the standard DIN rail.

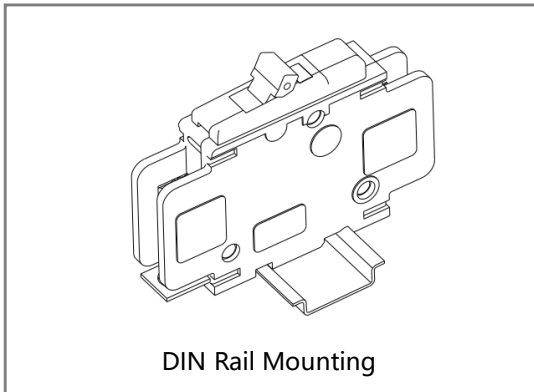
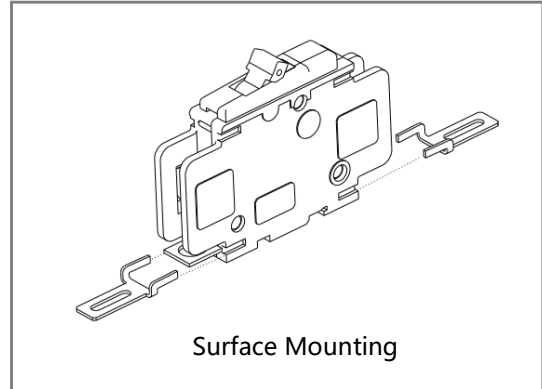
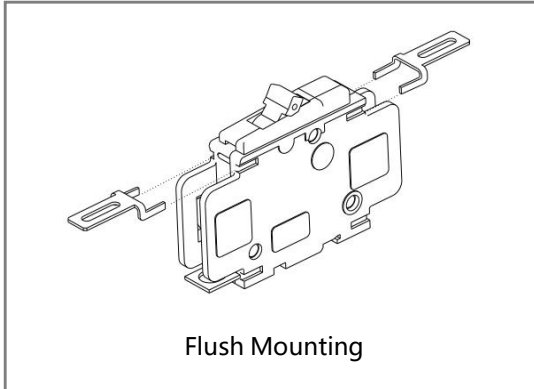

■ Connecting Wires

See circuit breaker for lug wire range and tightening torque.

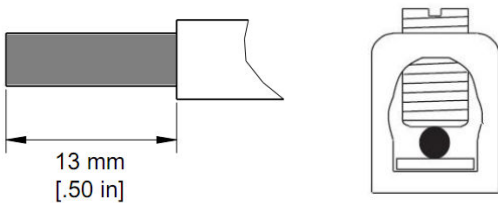

Terminal Screw: Torque 45 LB-IN

UCB Modular DIN-rail devices
Miniature Circuit Breakers

■ Tripping Curves -10A, 1P/2P

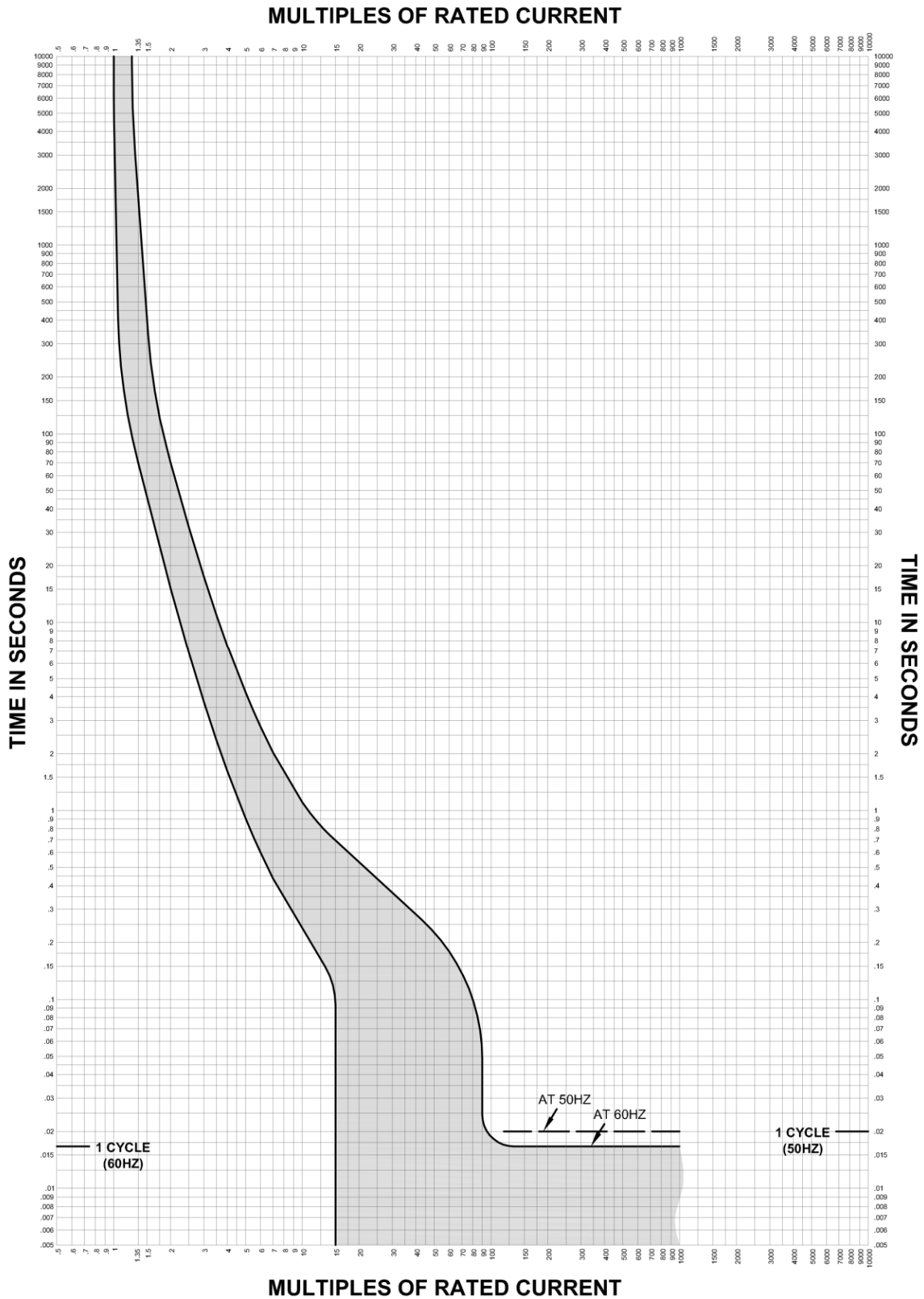

This curve is to be used for application and coordination purposes only. All time/Current curve data is based on 25°C ambient cold start. Terminations are made with conductors of appropriate length and ratings.

UCB Modular DIN-rail devices
Miniature Circuit Breakers

■ Tripping Curves -15A, 1P/2P/3P

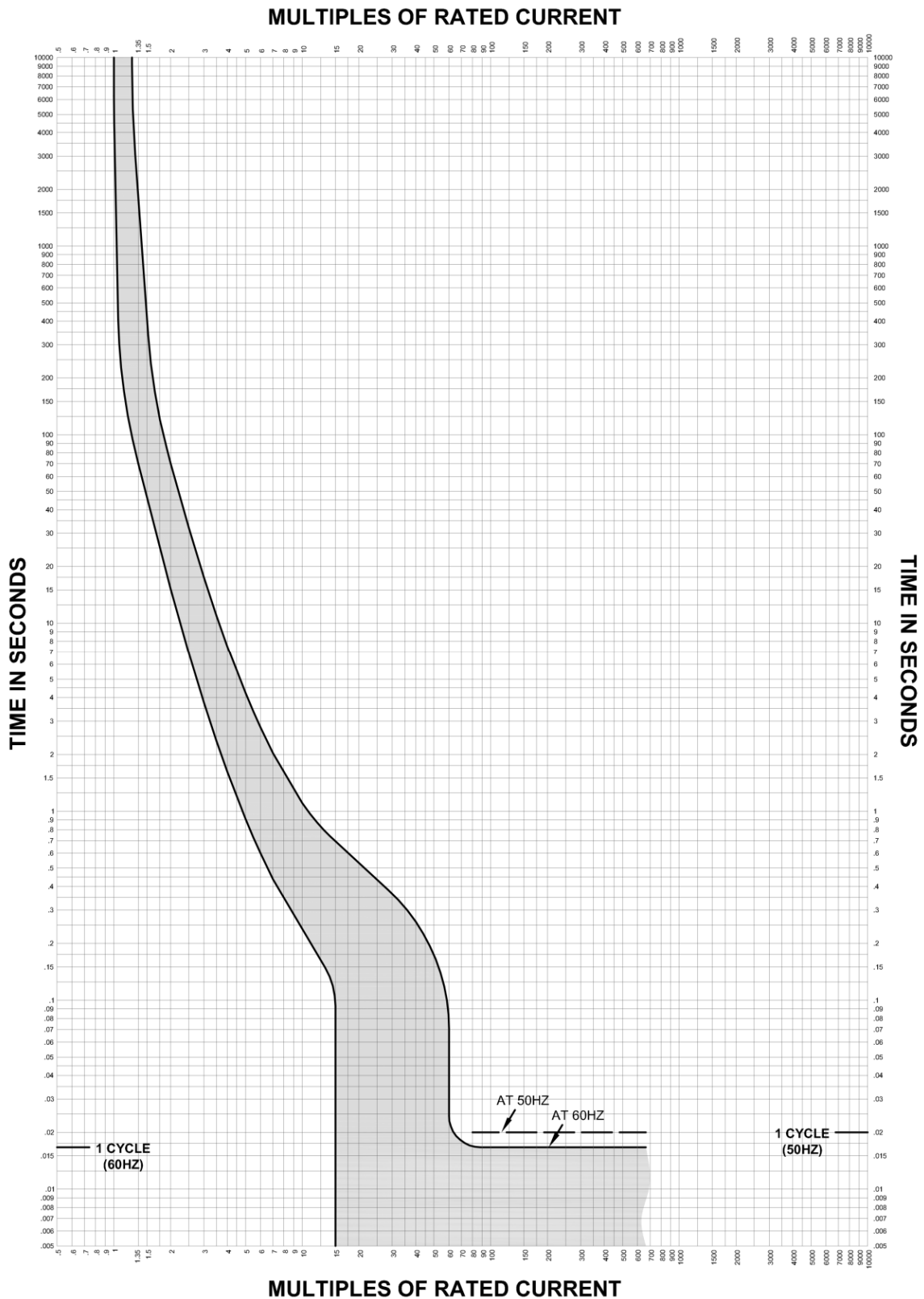

UCB Modular DIN-rail devices
Miniature Circuit Breakers

■ Tripping Curves -20A, 1P/2P/3P

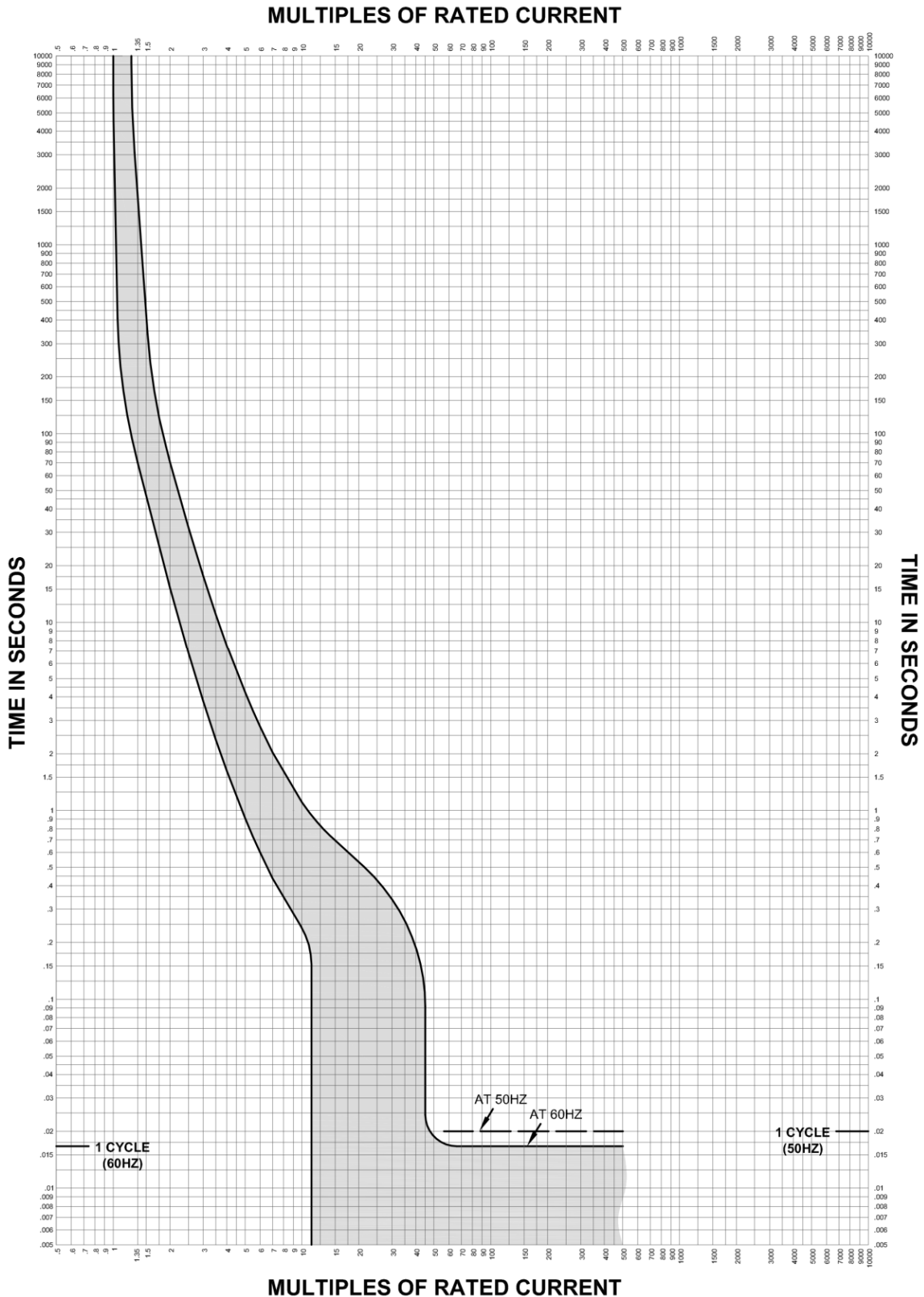

This curve is to be used for application and coordination purposes only. All time/Current curve data is based on 25°C ambient cold start. Terminations are made with conductors of appropriate length and ratings.

UCB Modular DIN-rail devices
Miniature Circuit Breakers

■ Tripping Curves -25A, 1P/2P/3P

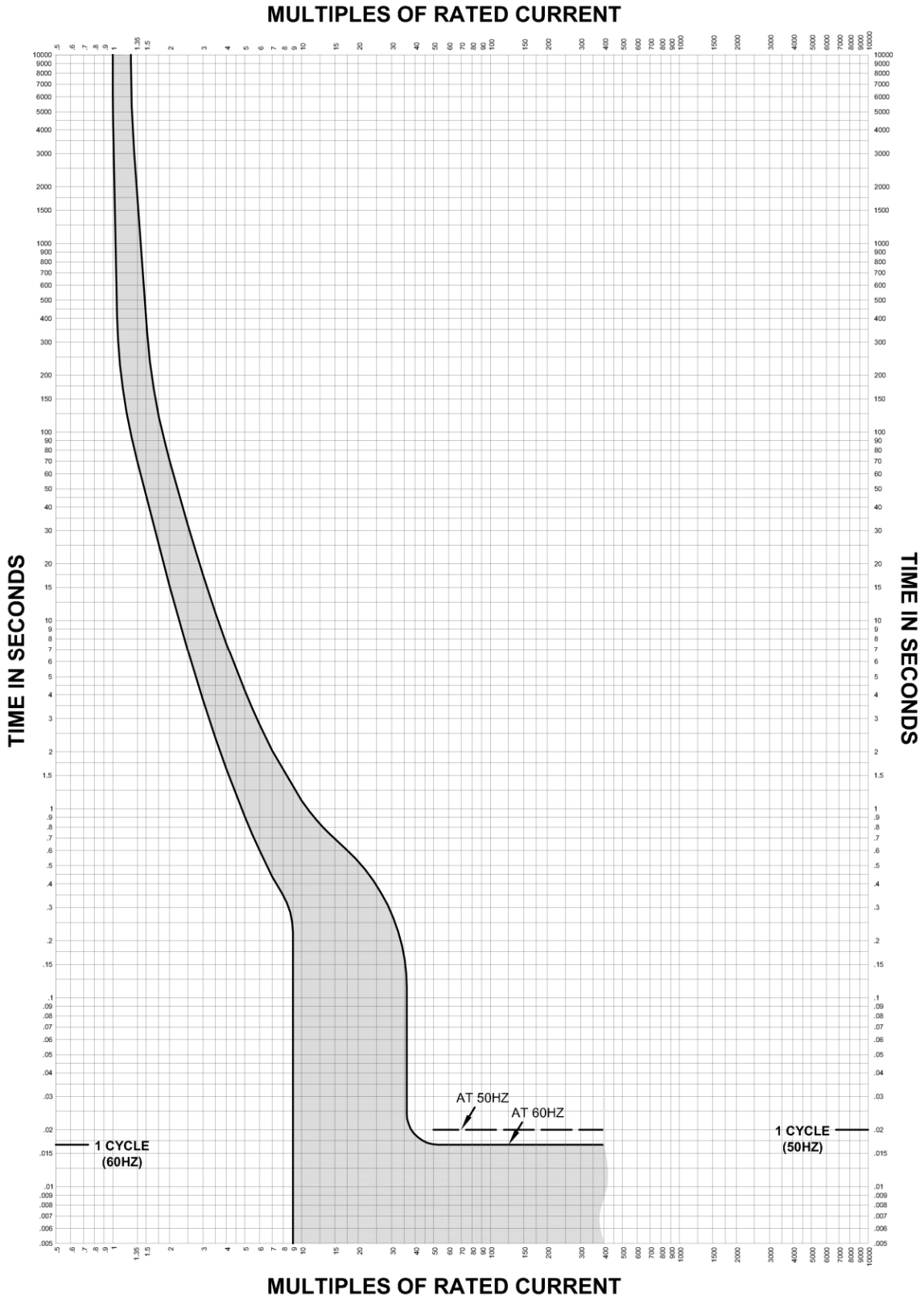

UCB Modular DIN-rail devices
Miniature Circuit Breakers

■ Tripping Curves -30A, 1P/2P/3P

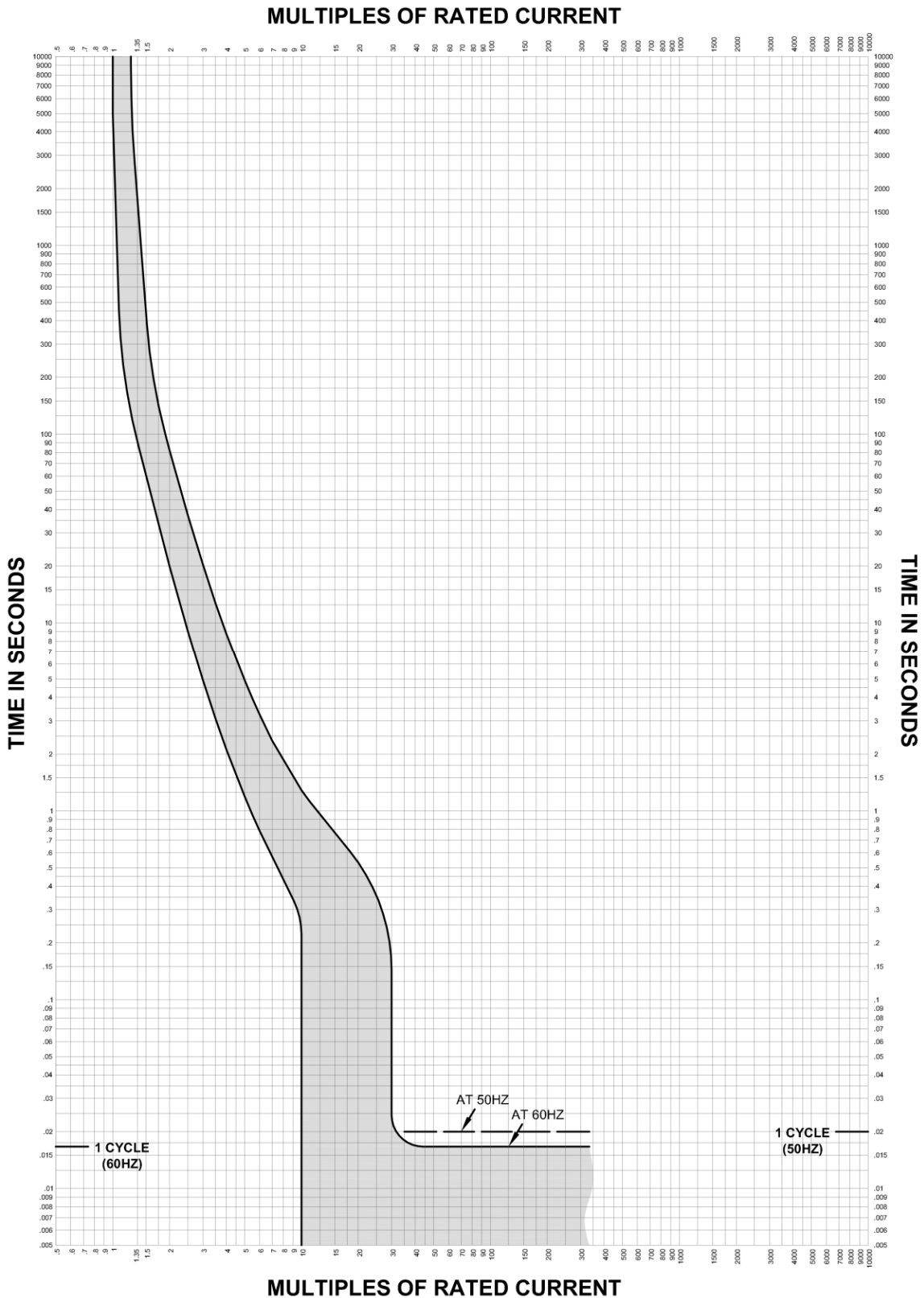

This curve is to be used for application and coordination purposes only. All time/Current curve data is based on 25°C ambient cold start. Terminations are made with conductors of appropriate length and ratings.

UCB Modular DIN-rail devices
Miniature Circuit Breakers

■ Tripping Curves -35A, 1P/2P/3P

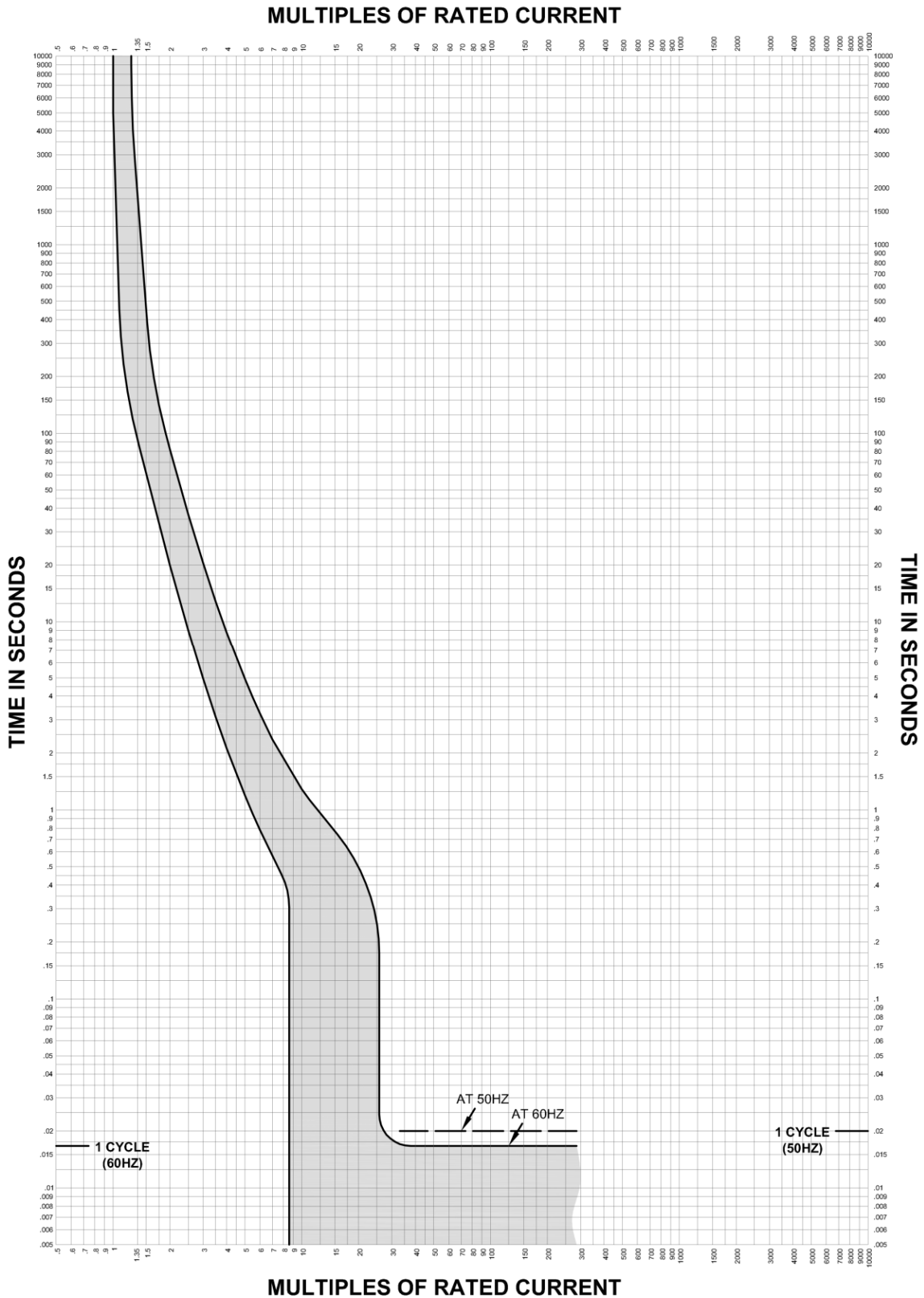

Miniature Circuit Breakers

■ Tripping Curves -40A, 1P/2P/3P

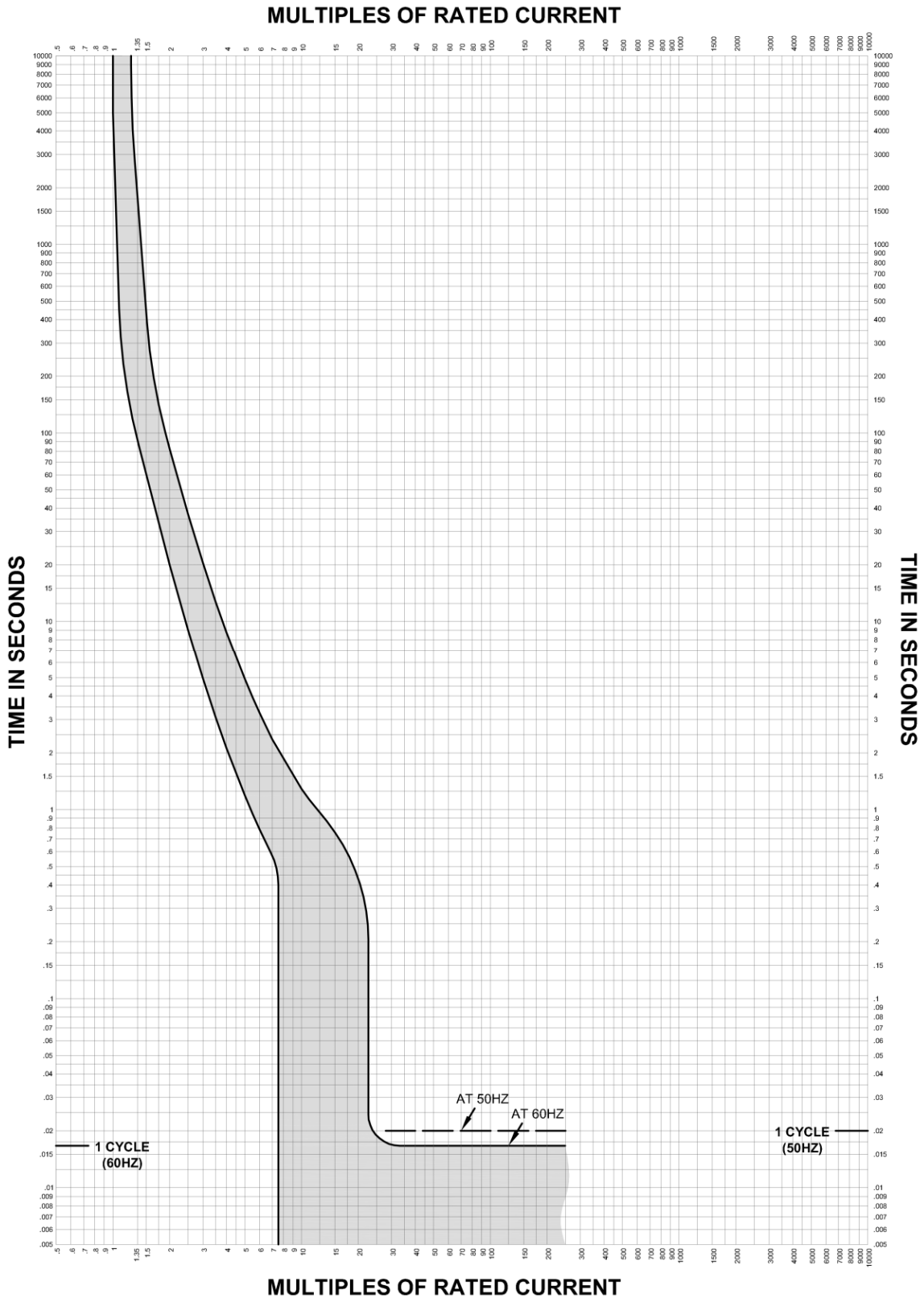

This curve is to be used for application and coordination purposes only. All time/Current curve data is based on 25°C ambient cold start. Terminations are made with conductors of appropriate length and ratings.

Miniature Circuit Breakers

■ Tripping Curves -45A, 1P/2P/3P

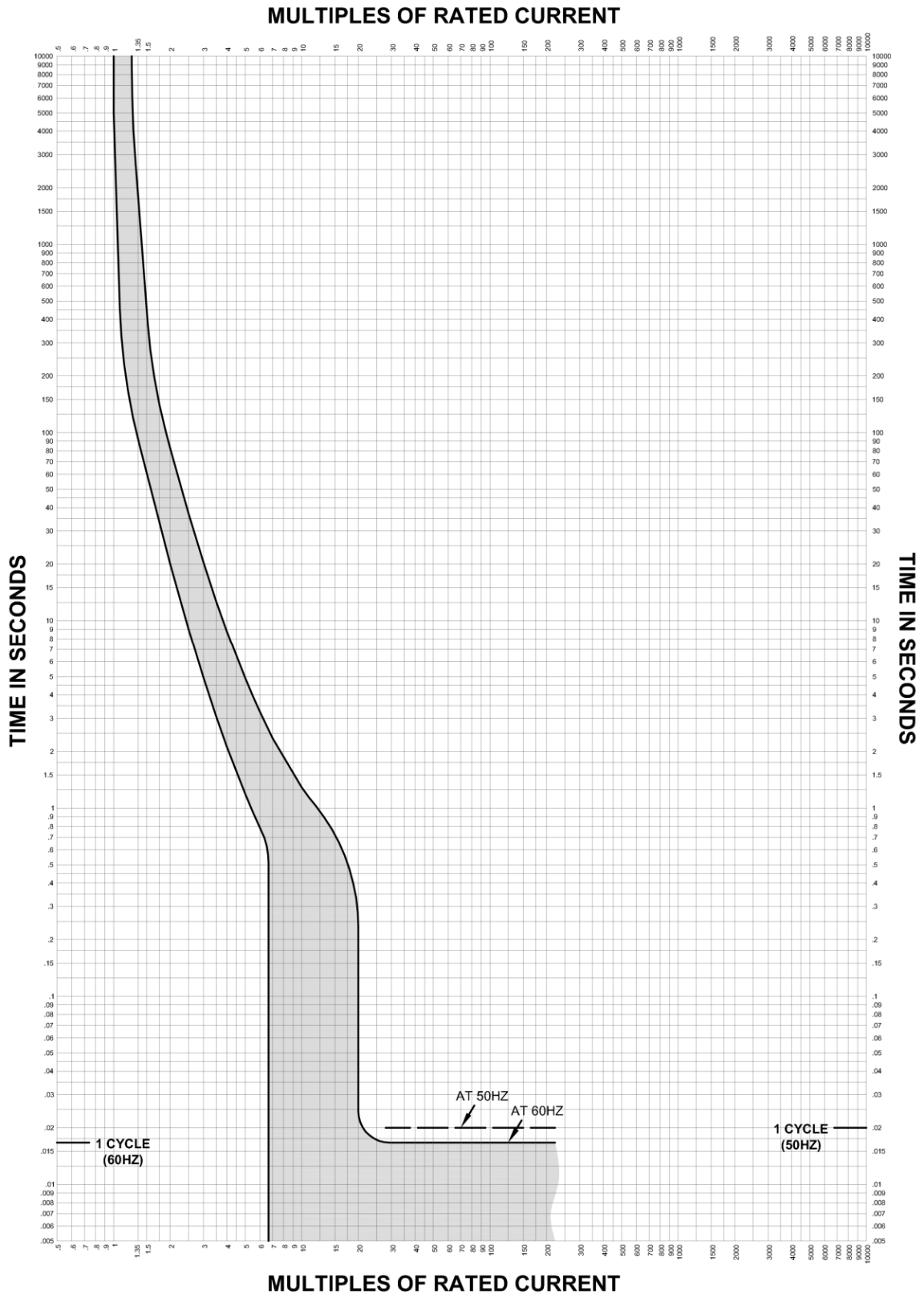

UCB Modular DIN-rail devices
Miniature Circuit Breakers

■ Tripping Curves -50A, 1P/2P/3P

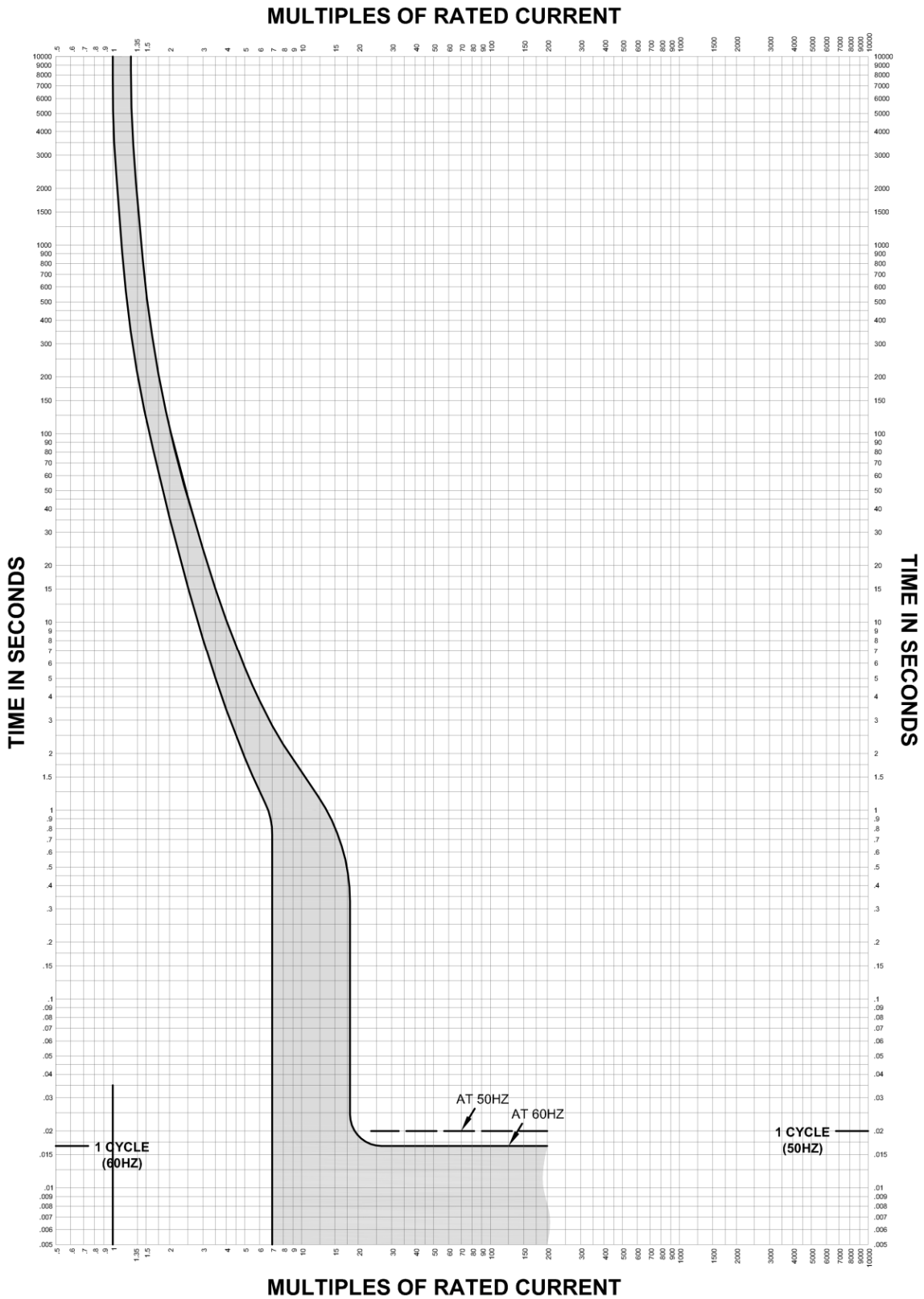

This curve is to be used for application and coordination purposes only. All time/Current curve data is based on 25°C ambient cold start. Terminations are made with conductors of appropriate length and ratings.

UCB Modular DIN-rail devices
Miniature Circuit Breakers

■ Tripping Curves -60A, 1P/2P/3P

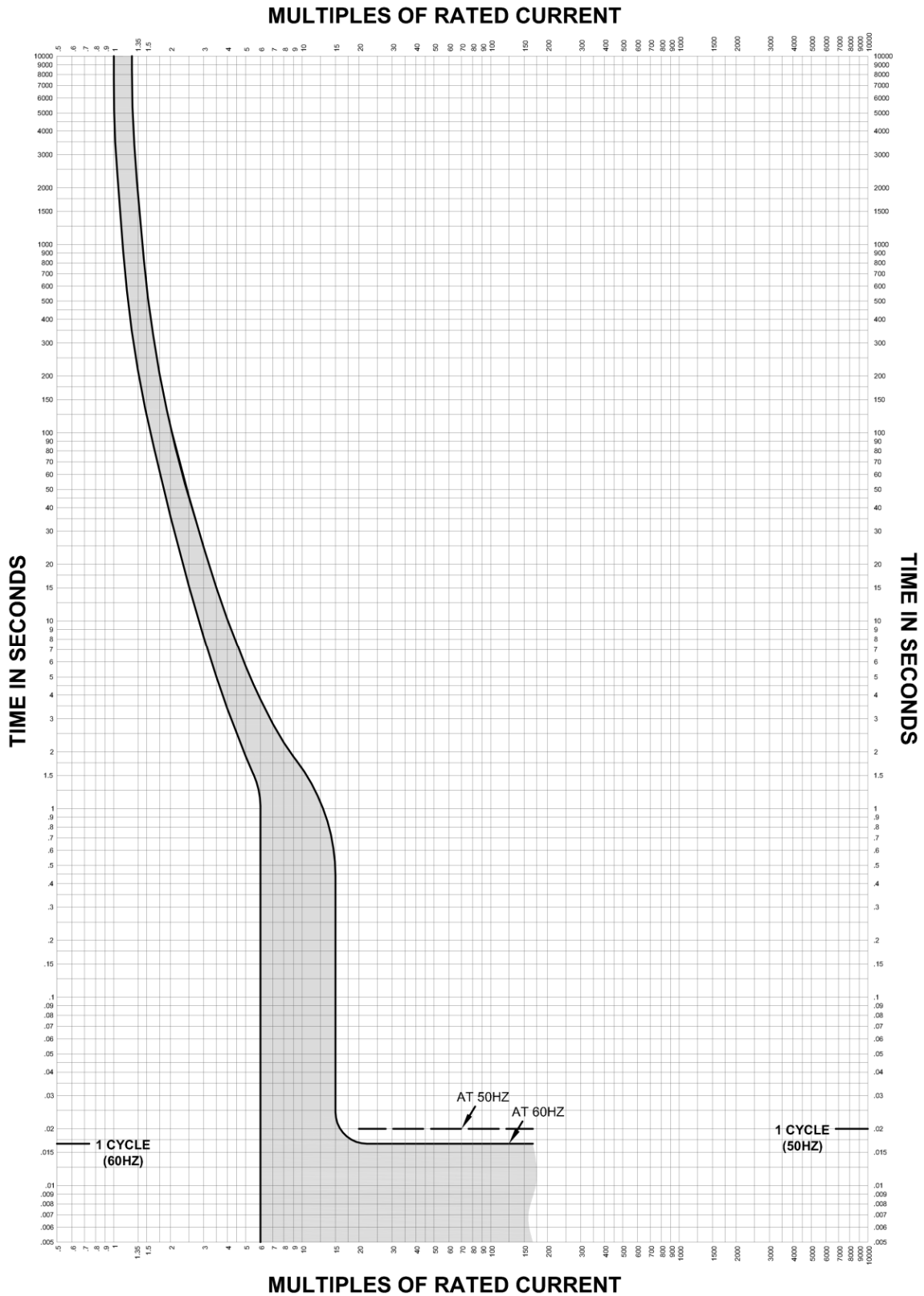

UCB Modular DIN-rail devices

Miniature Circuit Breakers

UCB Miniature Circuit Breakers, S-Std. Lugs on all terminals

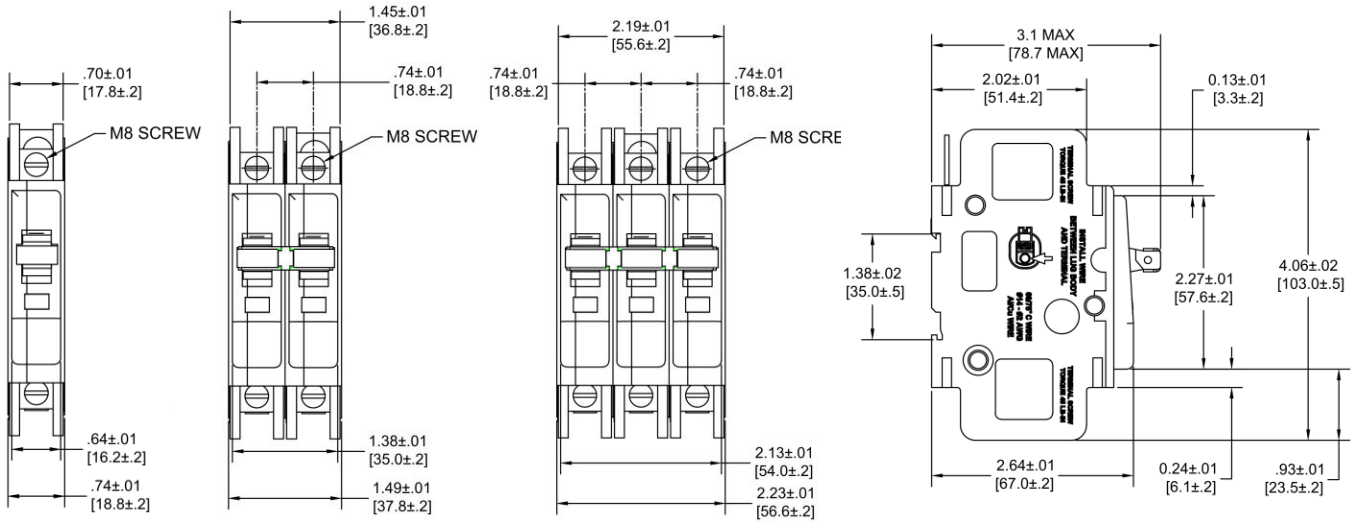

UCB Miniature Circuit Breakers, Q- Lugs on One Side / QC terminals on Opposite Side

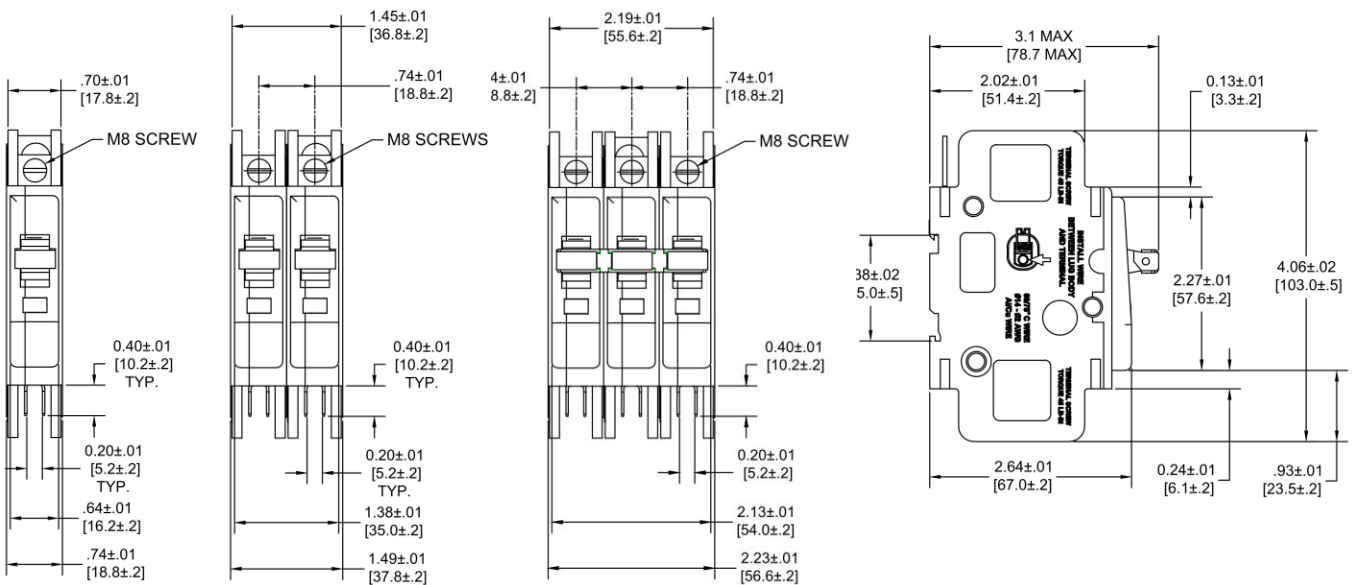

Miniature Circuit Breakers

■ UCB Miniature Circuit Breakers, S

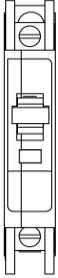
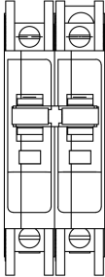
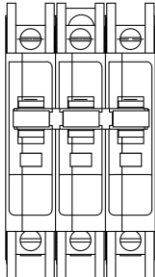
	Poles	Rated voltage	Interrupting Rating	Rated current	Cat. No.	Ref. No.
		V	kA	A		
	1P	AC 120/240	10	10	UCB1S10	US0001G
				15	UCB1S15	US0002G
				20	UCB1S20	US0003G
				25	UCB1S25	US0004G
				30	UCB1S30	US0005G
				35	UCB1S35	US0006G
				40	UCB1S40	US0007G
				45	UCB1S45	US0008G
				50	UCB1S50	US0009G
				60	UCB1S60	US0010G
	2P	AC 120/240	10	10	UCB2S10	US0011G
				15	UCB2S15	US0012G
				20	UCB2S20	US0013G
				25	UCB2S25	US0014G
				30	UCB2S30	US0015G
				35	UCB2S35	US0016G
				40	UCB2S40	US0017G
				45	UCB2S45	US0018G
				50	UCB2S50	US0019G
				60	UCB2S60	US0020G
	3P	AC 240	10	15	UCB3S15	US0022G
				20	UCB3S20	US0023G
				25	UCB3S25	US0024G
				30	UCB3S30	US0025G
				35	UCB3S35	US0026G
				40	UCB3S40	US0027G
				45	UCB3S45	US0028G
				50	UCB3S50	US0029G
				60	UCB3S60	US0030G

S-Std. Lugs on all terminals

Miniature Circuit Breakers

■ UCB Miniature Circuit Breakers, Q

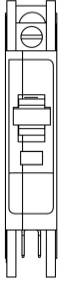
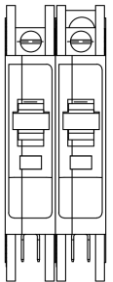
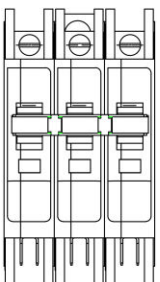
	Poles	Rated voltage	Interrupting Rating	Rated current	Cat. No.	Ref. No.
		V	kA	A		
	1P	AC 120/240	10	10	UCB1Q10	UQ0001G
				15	UCB1Q15	UQ0002G
				20	UCB1Q20	UQ0003G
				25	UCB1Q25	UQ0004G
				30	UCB1Q30	UQ0005G
				35	UCB1Q35	UQ0006G
				40	UCB1Q40	UQ0007G
				45	UCB1Q45	UQ0008G
				50	UCB1Q50	UQ0009G
				60	UCB1Q60	UQ0010G
	2P	AC 120/240	10	10	UCB2Q10	UQ0011G
				15	UCB2Q15	UQ0012G
				20	UCB2Q20	UQ0013G
				25	UCB2Q25	UQ0014G
				30	UCB2Q30	UQ0015G
				35	UCB2Q35	UQ0016G
				40	UCB2Q40	UQ0017G
				45	UCB2Q45	UQ0018G
				50	UCB2Q50	UQ0019G
				60	UCB2Q60	UQ0020G
	3P	AC 240	10	15	UCB3Q15	UQ0022G
				20	UCB3Q20	UQ0023G
				25	UCB3Q25	UQ0024G
				30	UCB3Q30	UQ0025G
				35	UCB3Q35	UQ0026G
				40	UCB3Q40	UQ0027G
				45	UCB3Q45	UQ0028G
				50	UCB3Q50	UQ0029G
				60	UCB3Q60	UQ0030G

Q- Lugs on One Side / QC terminals on Opposite Side

GEIS

GEIS Electric

Website: www.geis.tech

Hotline: +86 400-820-5234

This catalog may be subjected to revision without prior notice.
Version No.: GENCLVAZ26V2

